

**Team Corporation**  
11591 Watertank Road  
Burlington, WA 98233  
Tel: (360) 757-8601  
Fax: (360) 757-4401  
sales@teamcorporation.com  
www.teamcorporation.com

**Team Corporation UK**  
**Team Corporation UK Ltd**  
11 Old Ladies Court  
High Street  
Battle  
East Sussex  
TN33 0AH  
United Kingdom  
Tel: +44 (0) 1424 777004  
Fax: +44 (0) 1424 777005  
sales@teamcorporation.co.uk  
service@teamcorporation.co.uk  
www.teamcorporation.co.uk

# Hydrostatic Spherical Couplings

The *Team* Hydrostatic Spherical Coupling transmits tensile and compressive forces while allowing angular misalignment.

Our Hydrostatic Spherical Coupling find applications in multi axis vibration, structural fatigue testing, and any situation where angular movement is required. Each coupling connects the vibration system (Hydraulic or Electrodynamic) to the table/test article, protecting the system from damage due to misalignment or angular motion.

Single and Double pivot couplings are available, in either 0.5 degree or 6 degree configurations. Our double pivot couplings allow for angular and lateral misalignment. Each spherical surface is hydrostatically lubricated for extremely high stiffness, zero backlash, and infinite life.

## Features:

- Direct Load Path
- Eliminates Backlash
- Eliminates Friction
- Easy to Install
- Offers flexibility of Installation
- Low Maintenance, Long Life Product

## Applications:

- Multi-Axis Test Systems
- Custom Designed Test Rigs

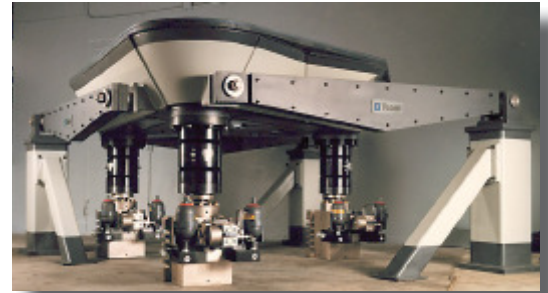

**420.XX**  
Provides a single pivot with  $\pm 0.5$  degrees of rotation, which will allow for angular misalignment.

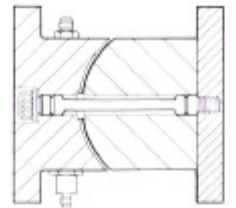

**421.XX**  
Provides a single pivot with  $\pm 6$  degrees of rotation, which will allow for angular misalignment.

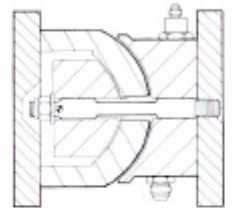

**422.XX**  
Provides a double pivot, allowing correction for angular and lateral misalignment. Angular capability is  $\pm 0.5$  degrees at each pivot.

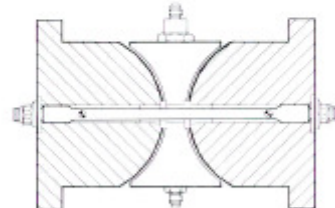

**423.XX**  
Provides a double pivot, allowing correction for angular & lateral misalignment. Angular capability is  $\pm 6$  degrees at each pivot.

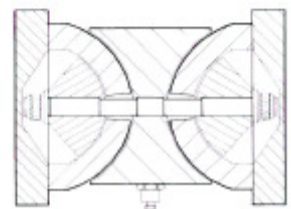

# Sample Specifications

	A, mm	B, mm	C, mm	D, mm	E, mm	F, mm	Wt. kg
420.10	203.2	190.5			152.4	10.16	11.3
420.20	254.0	228.6			203.2	13.46	22.7
420.40	266.7	304.8			279.4	13.46	38.5
420.60	480.0	400.0			355.6	16.51	170
420.15	604.5	558.8	251.0	65.27	508.0	26.16	544
421.10	230.2	190.5			152.4	10.16	12.7
421.20	254.0	228.6			203.2	13.46	25.0
421.40	292.1	355.6	25.40	21.59	317.5	13.46	40.8
422.10	254.0	172.7	31.75	25.40	152.4	10.16	13.6
422.20	304.8	254.0			203.2	10.16	27.2
422.40	609.6	330.2			304.8	13.46	90.7
423.20	317.5	228.6	31.75	44.45	203.2	10.16	36.3
423.40	457.2	374.7			330.2	19.81	90.7



## HYDROSTATIC SPHERICAL COUPLING

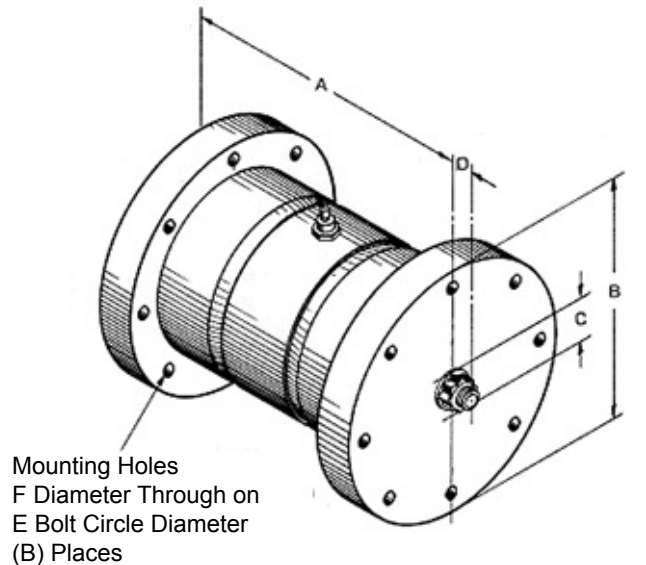

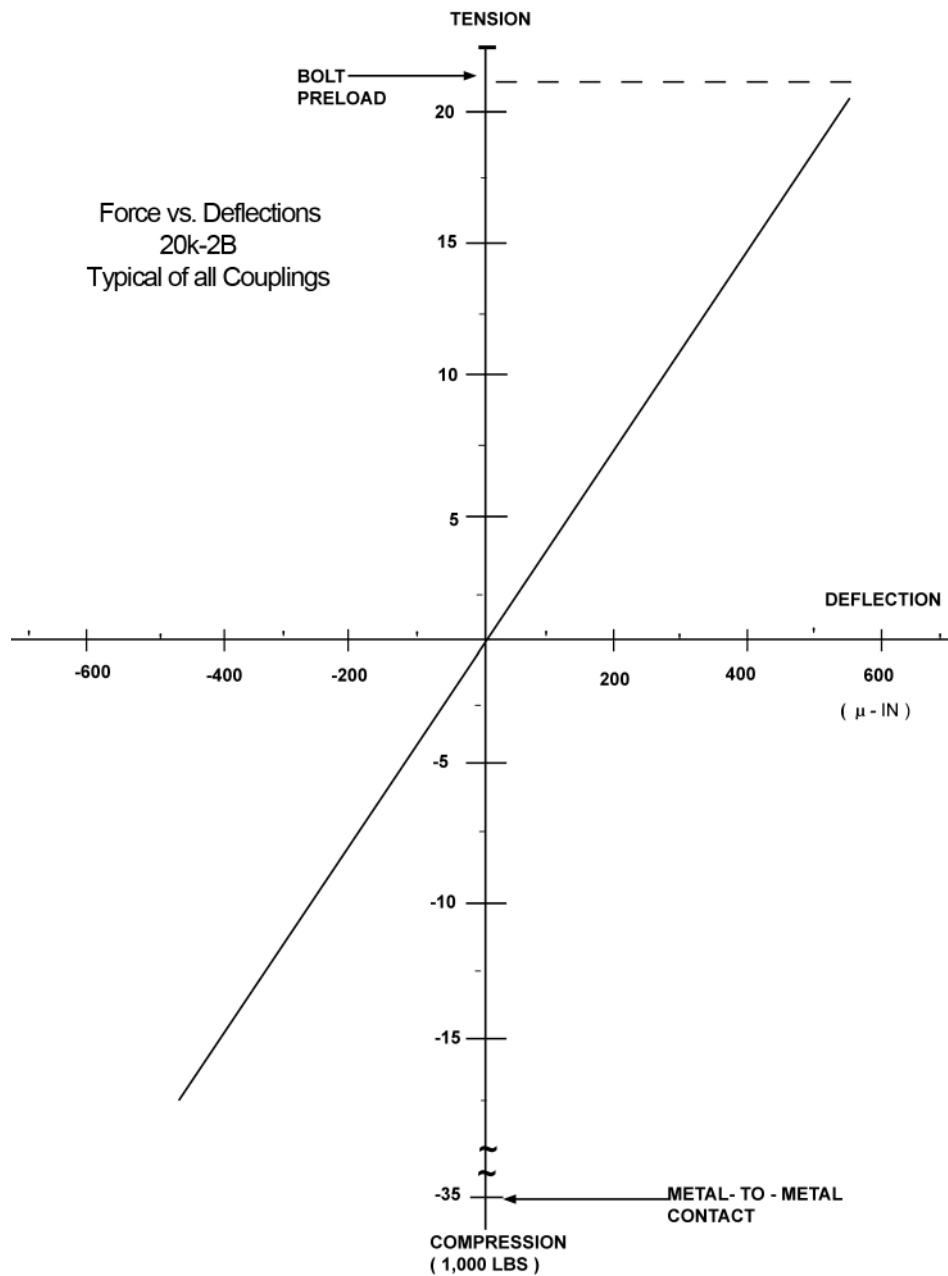

The 420 & 421 type of coupling is limited in its angular motion by the amount of bending permissible in the preload bolt. The maximum practical limit varies from  $\pm 1/2$  to  $\pm 5^\circ$  depending on coupling size.

There is one Spherical Hydrostatic Bearing Surface. The oil film is approximately .0005-.001 inches thick. In calculating axial stiffness the coupling may be modeled as three springs in series, two springs representing the material and a third spring representing the oil film. Because the oil film is at least 10 times stiffer than the material, a conservative measure of axial stiffness would be to assume the coupling to be a solid cylinder of steel or aluminum and calculate  $K = \frac{EA}{L}$ . The 422 & 423 models may be analyzed in a similar way.

The 422 & 423 type have two oil surfaces and does not require the bolt to bend. It is capable of  $\pm 6^\circ$  before reaching its mechanical limit.

$$\left[ \frac{K_{\text{COUPLING}} = K_{\text{OIL}} K_{\text{MATL}} + K_{\text{BOLT}}}{K_{\text{OIL}} + K_{\text{MATL}}} \right] \quad K_{\text{BOLT}} \ll K_{\text{MATL}} \ll K_{\text{OIL}}$$

The spring rate of the coupling in tension is equal to the spring rate in compression until the bolt preload is reached. At this point the coupling spring rate becomes equal to the bolt spring rate alone.



### U.S. Headquarters

Team Corporation  
11591 Watertank Road  
Burlington, WA 98233  
USA

Tel: (360) 757-8601  
Fax: (360) 757-4401

[sales@teamcorporation.com](mailto:sales@teamcorporation.com)  
[www.teamcorporation.com](http://www.teamcorporation.com)



### UK Headquarters

Team Corporation UK  
Team Corporation UK Ltd  
11 Old Ladies Court  
High Street  
Battle  
East Sussex  
TN33 0AH  
United Kingdom

Tel: +44 (0) 1424 777004  
Fax: +44 (0) 1424 777005

[sales@teamcorporation.co.uk](mailto:sales@teamcorporation.co.uk)  
[service@teamcorporation.co.uk](mailto:service@teamcorporation.co.uk)  
[www.teamcorporation.co.uk](http://www.teamcorporation.co.uk)

*A wholly owned subsidiary of Team Corporation*

